



Shenzhen Upcera Dental Technology Co., Ltd

5th Floor, Tsinghua IT Port R&B Bldg. B, Shenzhen,
Guangdong, China

+86 755-8882-0818
sales@upcera.com
dental.upcera.com



Reliable Materials Expert

PRODUCT CATALOG

Meet All Your Need



CE

ISO13485

FDA

Health Canada

KFDA

GOST

01

Zirconia Family

All Zirconia You Need	03
HT White	11
ST Series	13
TT ONE Series	17
TT Series	21
Explore Series	23

02

Dental Consumables

Realism Glaze Paste	30
PMMA	31
Wax	32
Grinding Tools	33
Corundum Sands	36
Sintering Beads	36
Laboratory Handpiece	37

03

Digital Dental Solutions

P2 + - 3D Intraoral Scanner	41
P3 - 3D Intraoral Scanner	43
U5 - True Color Texture Scanner	45
A41 - 4-Axis Dry Milling Machine	47
A51 - 5-Axis Dry Milling Machine	49
A52 - 5-Axis Dry Milling Machine	50
A52W - 5-Axis Wet Milling Machine	51
A53 - 5-Axis Disc Changer Milling Machine	54
B42 - Pre-milled Abutment Milling Machine	57
B52 - Screw-retained Bridge & Bar Milling Machine	58
C41 - 4-Axis Wet Milling Machine	59
D41 - Titanium Denture Framework Milling Machine	60
GT1 - Zirconia Sintering Furnace	61
C1 - Speed Sintering Furnace	62
A7+ - Porcelain Furnace	63

CONTENT

Reliable Materials Expert

01

















ZIRCONIA FAMILY

All Zirconia You Need

All Zirconia You Need

For All Indications

	 White	 Pre-shaded	 Multilayer
3Y-TZP-A	 HT White		
3Y-TZP	 ST White	 ST Pre-shaded	 ST Multilayer
4Y-PSZ	 TT ONE	 TT ONE Pre-shaded	 TT ONE Multilayer
5Y-PSZ	 TT White		 TT Multilayer
3Y-TZP-4Y-PSZ			 Explore Functional
4Y-PSZ-5Y-PSZ			 Explore Esthetic



⊙ HT White

Translucency	39%
Strength	1300Mpa
Restoration Type	Coping
Sintering Temperature	1530°C

⊙ ST Series

Translucency	43%
Strength	1300Mpa
Restoration Type	Coping Full Contour Crown
Sintering Temperature	1530°C



⊙ TT ONE Series

Translucency	47%
Strength	1000Mpa
Restoration Type	Full Contour Crown
Sintering Temperature	1480°C

⊙ TT Series

Translucency	49%
Strength	600Mpa
Restoration Type	Full Contour Crown (Aesthetic)
Sintering Temperature	1450°C

The New Generation of Materials

For All Indications



⊙ Explore Functional





Translucency	43%-46.6%
Strength	1027Mpa-1300Mpa
Restoration Type	Full Contour Crown
Sintering Temperature	1480°C

⊙ Explore Esthetic

Translucency	47%-48.8%
Strength	727Mpa-1000Mpa
Restoration Type	Full Contour Crown (Aesthetic)
Sintering Temperature	1480°C

Specification

All Popular Systems Available

Applied For	Specification(mm)	Package	HT White	ST White	ST Pre-shaded	ST Multilayer	TT White	TT Multilayer	TT ONE Pre-shaded	TT ONE Multilayer	Explore Functional	Explore Esthetic
 <p>Open CAD/CAM System</p>	D98x10(stepless)	1pc/box	✓	✓	✓		✓					
	D98x12(step&stepless)	1pc/box	✓	✓	✓	✓	✓	✓	✓	✓	✓	✓
	D98x14(step&stepless)	1pc/box	✓	✓	✓	✓	✓	✓	✓	✓	✓	✓
	D98x16(step&stepless)	1pc/box	✓	✓	✓	✓	✓	✓	✓	✓	✓	✓
	D98x18(step&stepless)	1pc/box	✓	✓	✓	✓	✓	✓	✓	✓	✓	✓
	D98x20(step&stepless)	1pc/box	✓	✓	✓	✓	✓	✓	✓	✓	✓	✓
	D98x22(step&stepless)	1pc/box	✓	✓	✓	✓	✓	✓	✓	✓	✓	✓
	D98x25(step&stepless)	1pc/box	✓	✓	✓	✓	✓	✓	✓	✓	✓	✓
 <p>Cerec in lab (Sirona) System</p>	20x14x15	12pcs/box	✓	✓	✓		✓					
	20x19x15	10pcs/box	✓	✓	✓	✓	✓		✓	✓	✓	✓
	40x14x15	8pcs/box	✓	✓	✓		✓					
	40x19x15	6pcs/box	✓	✓	✓	✓	✓		✓	✓	✓	✓
	55x19x15	5pcs/box	✓	✓	✓	✓	✓	✓		✓	✓	✓
	65x25x22	4pcs/box	✓	✓	✓	✓	✓	✓		✓	✓	✓
	65x40x22	2pcs/box	✓	✓	✓		✓					
	85x40x22	2pcs/box	✓	✓	✓		✓					
 <p>Zirkonzahn CAD/CAM System</p>	D95x10	1pc/box	✓	✓	✓		✓					
	D95x12	1pc/box	✓	✓	✓		✓					
	D95x14	1pc/box	✓	✓	✓	✓	✓	✓	✓	✓	✓	✓
	D95x16	1pc/box	✓	✓	✓	✓	✓	✓	✓	✓	✓	✓
	D95x18	1pc/box	✓	✓	✓	✓	✓	✓	✓	✓	✓	✓
	D95x20	1pc/box	✓	✓	✓	✓	✓	✓	✓	✓	✓	✓
	D95x22	1pc/box	✓	✓	✓	✓	✓	✓	✓	✓	✓	✓
	D95x25	1pc/box	✓	✓	✓	✓	✓	✓	✓	✓	✓	✓
 <p>Amann Girrbach CAD/CAM System</p>	89x71x10	1pc/box	✓	✓	✓		✓					
	89x71x12	1pc/box	✓	✓	✓		✓					
	89x71x14	1pc/box	✓	✓	✓	✓	✓	✓	✓	✓	✓	✓
	89x71x16	1pc/box	✓	✓	✓	✓	✓	✓	✓	✓	✓	✓
	89x71x18	1pc/box	✓	✓	✓	✓	✓	✓	✓	✓	✓	✓
	89x71x20	1pc/box	✓	✓	✓	✓	✓	✓	✓	✓	✓	✓
	89x71x22	1pc/box	✓	✓	✓	✓	✓	✓	✓	✓	✓	✓
	89x71x25	1pc/box	✓	✓	✓	✓	✓	✓	✓	✓	✓	✓

Indication Guide

Suitable for All Indications

Indications	Veneers	Inlays/onlays	Full contour anterior crown	Anterior bridge (3 units)	Full contour posterior crown	Posterior bridge (3 units)	Full contour bridge (4 units)	Full contour bridge (≥4 units)	Anterior coping	Anterior coping bridge (3 units)	Posterior coping	Reduced posterior bridge (3 units)	Reduced posterior bridge (4units)	Reduced posterior bridge (≥4units)
HT White	●	●	●	●	●	●	●	●	★	★	★	★	★	★
ST White	●	●	●	●	✓	✓	✓	★	★	★	★	★	★	★
ST Pre-shaded	●	●	●	●	✓	✓	✓	★	★	★	★	★	★	★
ST Multilayer	●	●	●	●	✓	✓	✓	★	★	★	★	★	★	★
TT ONE White	●	●	✓	✓	★	★	★	✓	✓	✓	✓	✓	✓	●
TT ONE Pre-shaded	●	●	✓	✓	★	★	★	✓	✓	✓	✓	✓	✓	●
TT ONE Multilayer	●	●	✓	✓	★	★	★	✓	✓	✓	✓	✓	✓	●
TT White	●	●	★	★	★	★	×	×	✓	✓	✓	✓	×	×
TT Multilayer	●	●	★	★	★	★	×	×	✓	✓	✓	✓	×	×
Explore Functional	●	●	✓	✓	★	★	★	✓	✓	✓	✓	✓	✓	✓
Explore Esthetic	●	●	★	★	★	★	●	×	✓	✓	✓	✓	●	×

★ optimum ✓ available ● available but not recommended × unavailable



HT White

UPCERA HT White, made of 3Y-TZP, is a high translucent zirconia blank used for monolithic or anatomically reduced anterior restorations and framework bridges with porcelain build-up. It offers a good choice of high strength to the labs.



Translucency

39%

Strength

1300Mpa

Highlights

- Ideal for coping and framework
- Ultra-high strength, reduces the fracture risk

Physical Characteristics

Density after sintering	6.07±0.01g/cm ³
CTE (25-500°C)	(10.5±0.5)×10 ⁻⁶ K ⁻¹
Accelerated aging surface monoclinic phase content	<10%
Chemical solubility after sintering	<100µg/cm ²
Radioactivity	<0.1Bq/g
Sintering temperature	1530°C

Chemical Composition

ZrO ₂ + HfO ₂ + Y ₂ O ₃	>99%
Y ₂ O ₃	4.5%-6%
Al ₂ O ₃	<0.5%
Others oxides	<0.5%



ST Series

UPCERA ST, where the beauty starts. It is one of the most classical lines of pre-shaded zirconia, today you have the options of white, mono-shade, and multi-shaded. With an upper yield of 1300Mpa, ST is a true "general variety" product.

ST White



Translucency
43%

Strength
1300Mpa

Highlights

- Aesthetic effects with a wide range of indications
- Individual infiltration and staining technique available

Physical Characteristics

Density after sintering	6.07±0.01g/cm ³
CTE (25-500°C)	(10.5±0.5)×10 ⁻⁶ K ⁻¹
Accelerated aging surface monoclinic phase content	<15%
Chemical solubility after sintering	<100µg/cm ²
Radioactivity	<0.1Bq/g
Sintering temperature	1530°C

Chemical Composition

ZrO ₂ + HfO ₂ + Y ₂ O ₃	>99%
Y ₂ O ₃	4.5%-6%
Al ₂ O ₃	<0.5%
Others oxides	<0.5%

ST Pre-shaded



Strength
1300Mpa

Indications
**Full contour crown
and bridge**

- Natural chroma
- Optimal stability and outstanding anti-aging performance

Shades



Physical Characteristics

Density after sintering	6.08±0.01g/cm ³
CTE(25-500°C)	(10.5±0.5)×10 ⁻⁶ K ⁻¹
Accelerated aging surface monoclinic phase content	<15%
Chemical solubility after sintering	<100µg/cm ²
Radioactivity	<0.1Bq/g
Sintering temperature	1530°C

Chemical Composition

ZrO ₂ + HfO ₂ + Y ₂ O ₃	>97%
Y ₂ O ₃	4.4%-5.5%
Al ₂ O ₃	<0.5%
Fe ₂ O ₃	<0.3%
Er ₂ O ₃	<1.0%
Others oxides	<1.2%

ST Multilayer



- Extraordinary mechinability, suitable for full contour crown and bridge
- Smooth gradient of chroma from the cervical to incisal

Strength
1300Mpa

Shades



Physical Characteristics

Density after sintering	6.08±0.01g/cm ³
CTE(25-500°C)	(10.5±0.5)×10 ⁻⁶ K ⁻¹
Accelerated aging surface monoclinic phase content	<15%
Chemical solubility after sintering	<100µg/cm ²
Radioactivity	<0.1Bq/g
Sintering temperature	1530°C

Chemical Composition

ZrO ₂ + HfO ₂ + Y ₂ O ₃	>97.7%
Y ₂ O ₃	4.4%-5.5%
Al ₂ O ₃	<0.5%
Fe ₂ O ₃	<0.3%
Er ₂ O ₃	<1.0%
Others oxides	<1.2%



TT ONE Series



TT ONE White



- Exceptional strength and transparency in one
- Superior customized staining

Translucency
47%

Strength
1000Mpa

**All
Indications**

Physical Characteristics

Density after sintering	≥6.0g/cm ³
CTE(25-500°C)	(10.5±0.5)×10 ⁻⁶ K ⁻¹
Accelerated aging surface monoclinic phase content	<5%
Chemical solubility after sintering	<100μg/cm ²
Radioactivity	<0.1Bq/g
Sintering temperature	1480°C

Chemical Composition

ZrO ₂ + HfO ₂ + Y ₂ O ₃	>96.5%
Y ₂ O ₃	5.8%-9.7%
Al ₂ O ₃	<0.5%
Fe ₂ O ₃	<0.5%
Er ₂ O ₃	<2.0%
Others oxides	<0.5%

UPCERA TT ONE, The worldwide popular zirconia model perfectly combines the high strength and great translucency for all indications.

TT ONE Pre-shaded

Strength
1000Mpa

Shades



Physical Characteristics

Density after sintering	$\geq 6.0 \text{g/cm}^3$
CTE(25-500°C)	$(10.5 \pm 0.5) \times 10^{-6} \text{K}^{-1}$
Accelerated aging surface monoclinic phase content	<5%
Chemical solubility after sintering	<100 $\mu\text{g/cm}^2$
Radioactivity	<0.1Bq/g
Sintering temperature	1480°C

Chemical Composition

ZrO ₂ + HfO ₂ + Y ₂ O ₃	>96.5%
Y ₂ O ₃	5.8%-9.7%
Al ₂ O ₃	<0.5%
Fe ₂ O ₃	<0.5%
Er ₂ O ₃	<2.0%
Others oxides	<0.5%

TT ONE Multilayer

Strength
1000Mpa

Shades



Physical Characteristics

Density after sintering	$\geq 6.0 \text{g/cm}^3$
CTE(25-500°C)	$(10.5 \pm 0.5) \times 10^{-6} \text{K}^{-1}$
Accelerated aging surface monoclinic phase content	<5%
Chemical solubility after sintering	<100 $\mu\text{g/cm}^2$
Radioactivity	<0.1Bq/g
Sintering temperature	1480°C

Chemical Composition

ZrO ₂ + HfO ₂ + Y ₂ O ₃	>96.5%
Y ₂ O ₃	5.8%-9.7%
Al ₂ O ₃	<0.5%
Fe ₂ O ₃	<0.5%
Er ₂ O ₃	<2.0%
Others oxides	<0.5%



TT Series



TT White



Translucency **49%** Strength **600Mpa**

- Superior light transmittance
- No porcelain required
- For true-to-life anterior restoration

Physical Characteristics

Density after sintering	$\geq 6.0 \text{g/cm}^3$
CTE(25-500°C)	$(10.5 \pm 0.5) \times 10^{-6} \text{K}^{-1}$
Accelerated aging surface monoclinic phase content	<5%
Chemical solubility after sintering	<100 $\mu\text{g/cm}^2$
Radioactivity	<0.1Bq/g
Sintering temperature	1450°C

Chemical Composition

ZrO ₂ + HfO ₂ + Y ₂ O ₃	>96.5%
Y ₂ O ₃	5.8%-9.7%
Al ₂ O ₃	<0.5%
Fe ₂ O ₃	<0.5%
Er ₂ O ₃	<2.0%
Others oxides	<0.5%

TT Multilayer



Strength **600Mpa**

- Optimized transparency
- Seamless transition of color

Physical Characteristics

Density after sintering	$\geq 6.0 \text{g/cm}^3$
CTE(25-500°C)	$(10.5 \pm 0.5) \times 10^{-6} \text{K}^{-1}$
Accelerated aging surface monoclinic phase content	<5%
Chemical solubility after sintering	<100 $\mu\text{g/cm}^2$
Radioactivity	<0.1Bq/g
Sintering temperature	1450°C

Chemical Composition

ZrO ₂ + HfO ₂ + Y ₂ O ₃	>96.5%
Y ₂ O ₃	5.8%-9.7%
Al ₂ O ₃	<0.5%
Fe ₂ O ₃	<0.5%
Er ₂ O ₃	<2.0%
Others oxides	<0.5%

Shades

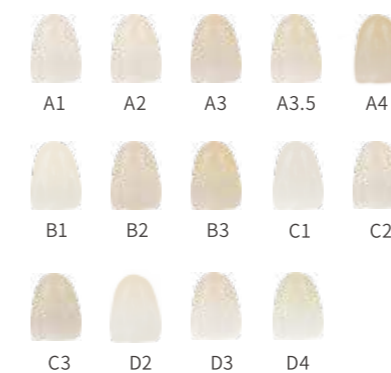



Explore Series

UPCERA Explore, the innovative and revolutionary zirconia that has the sweet spot between the strength and translucency. With the help of the Functional and Esthetic zirconia, the natural-looking restoration can be created in less amount of time. Try and explore a way to simplify the workflow and boost the profitability of your laboratory.

Highlights

- Precise pre-shading technology, efficient process
- Homogeneous layer distribution of color, strength and translucency
- All-purpose zirconia, delivering the great flexibility

Explore Functional

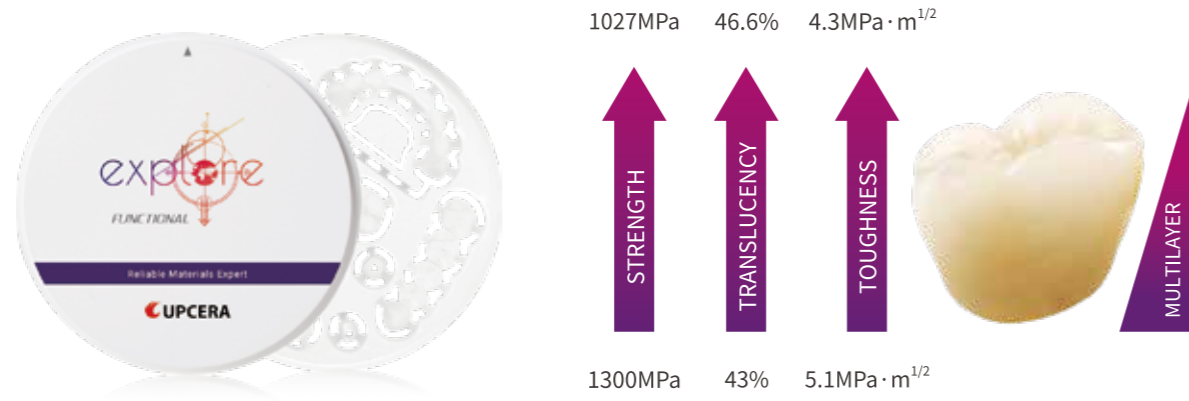

Shades



Physical Characteristics

Density after sintering	≥6.0g/cm ³
CTE(25-500°C)	(10.5±1.0)x10 ⁻⁶ K ⁻¹
Accelerated aging surface monoclinic phase content	<5%
Chemical solubility after sintering	<100µg/cm ²
Radioactivity	<0.1Bq/g
Sintering temperature	1480°C

Chemical Composition

ZrO ₂ + HfO ₂ + Y ₂ O ₃	>96.5%
Y ₂ O ₃	5.8%-9.7%
Al ₂ O ₃	<0.5%
Fe ₂ O ₃	<0.5%
Er ₂ O ₃	<2.0%
Others oxides	<0.5%

Explore Esthetic

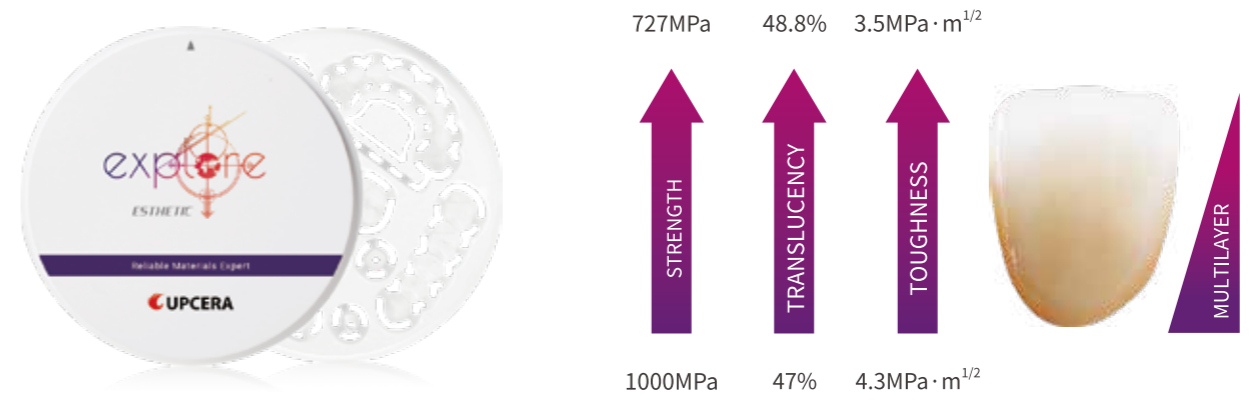

Shades



Physical Characteristics

Density after sintering	≥6.0g/cm ³
CTE(25-500°C)	(10.5±0.5)x10 ⁻⁶ K ⁻¹
Accelerated aging surface monoclinic phase content	<5%
Chemical solubility after sintering	<100µg/cm ²
Radioactivity	<0.1Bq/g
Sintering temperature	1480°C

Chemical Composition

ZrO ₂ + HfO ₂ + Y ₂ O ₃	>96.5%
Y ₂ O ₃	5.8%-9.7%
Al ₂ O ₃	<0.5%
Fe ₂ O ₃	<0.5%
Er ₂ O ₃	<2.0%
Others oxides	<0.5%

Sintering

Zirconia Sintering Programs

ST White

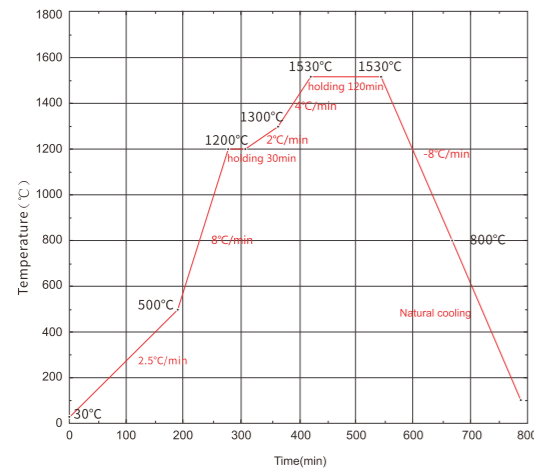

ST Pre-shaded \ ST ML

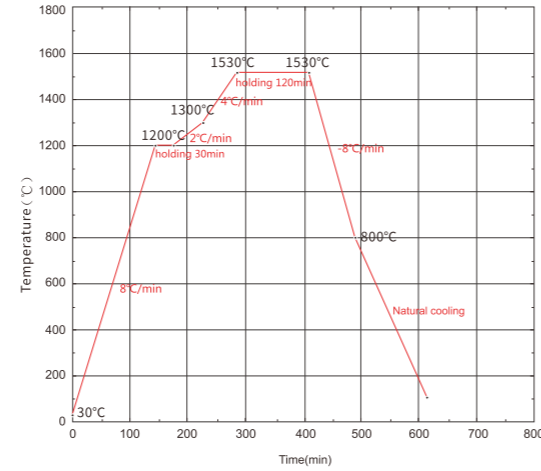

TT ML

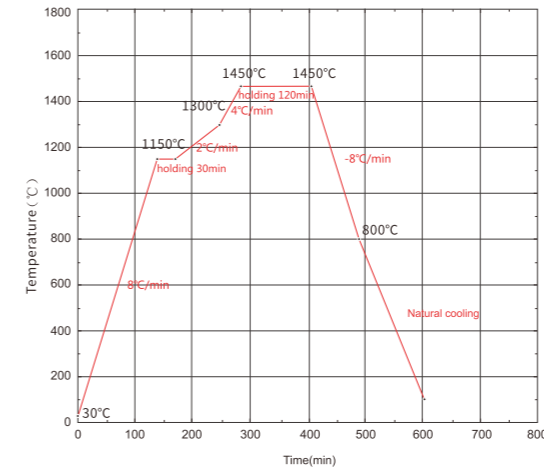

TT White \ TT ML

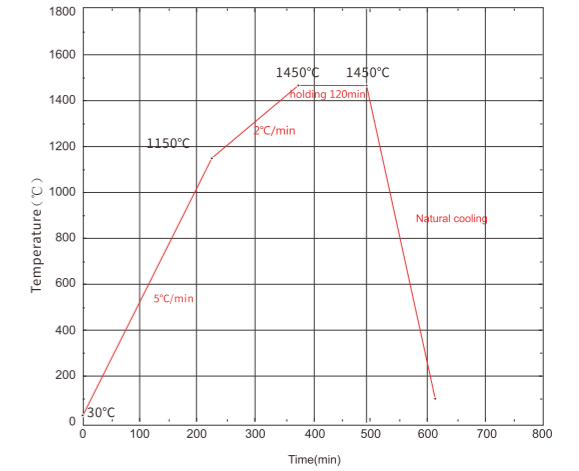

TT White

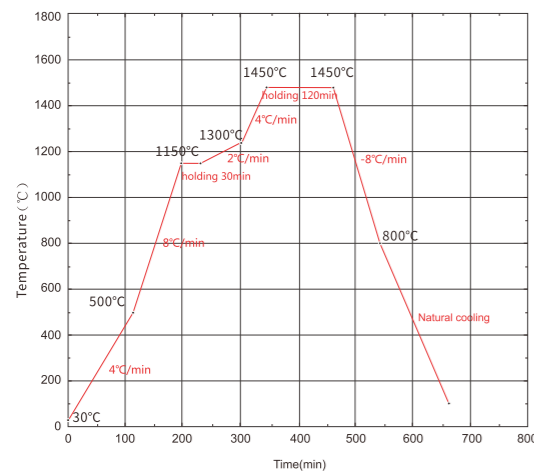

ST White \ ST Pre-shaded \ ST ML

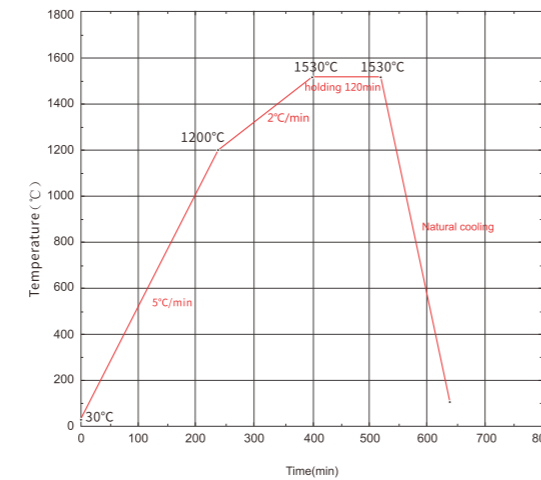

Explore Series \ TT ONE Pre-shaded \ TT ONE ML

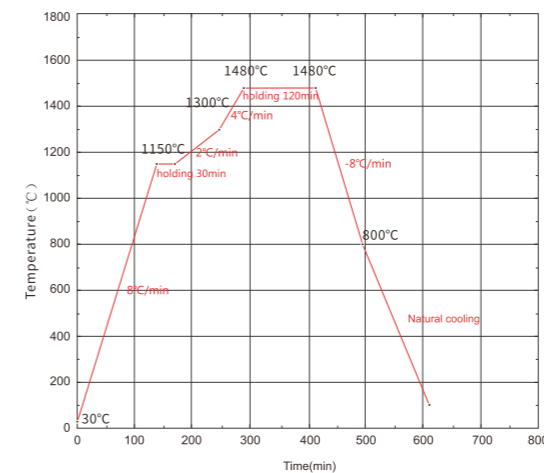

TT ONEWhite \ Explore White

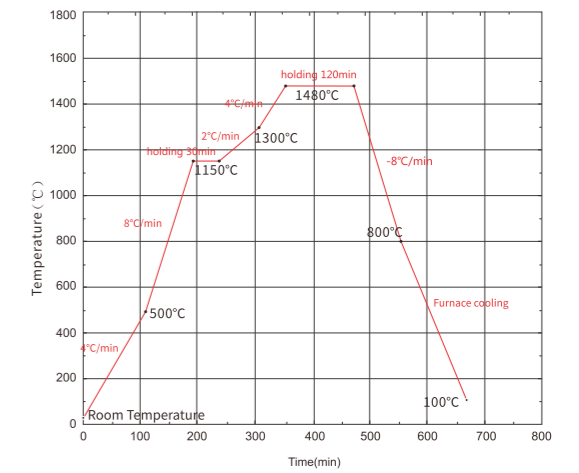

ATTENTION

Please be aware that variety of factors, such as the path of insertion, accuracy of the impression or digital scan file, CAD/CAM design, milling, staining, and the try-in skills, will impact on the final results. Please follow Upcera standard sintering programs to get the ideal outcomes. Do not hesitate to contact Upcera for any further questions.

02

Realism Glaze Paste

One Glaze Kit for All Ceramics

- UPCERA Independent R&D
- Optimized for Zirconia and Lithium Disilicate



DENTAL CONSUMABLES

BASIC



INCISAL



FOSSA



EFFECT



GINGIVAL



GLAZE



PMMA

- Excellent abrasion resistance and no deformation
- Available for single shade and multi-shaded



Technical Parameter

Flexural strength	≥100MPa
Water absorption value	≤40μg/cm ³
Dissolved value	≤7.5μg/cm ³

Chemical Composition

Methacrylic acid polymer	~99%
Pigment	≤1%

Specification

S (Monochrome)	A1 A2 A3 A3.5 A4 B1 B2 B3 B4 C1 C2 C3 C4 D2 D3 D4 Pink1/2/3 Clear
M (Multilayer)	A1 A2 A3 A3.5 A4 B1 B2 B3 B4 C1 C2 C3 C4 D2 D3 D4

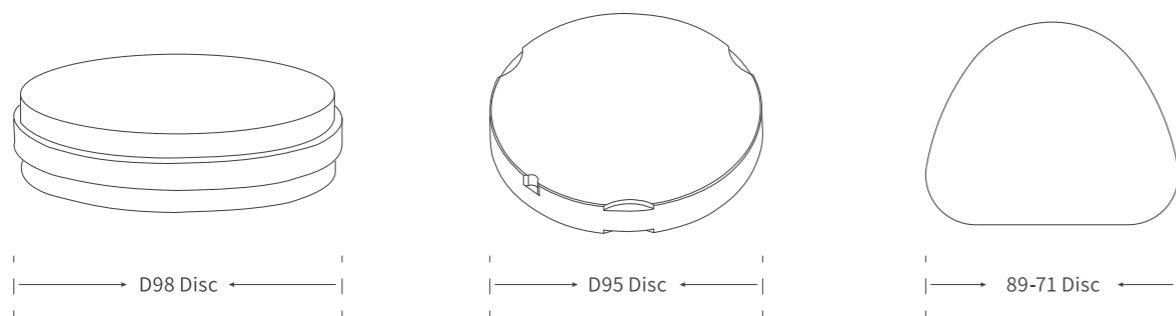

Wax

- Burning without residue
- Great machinability



Technical Parameter

Melting point	110-115°C
Hardness	45-55°
Coefficient of thermal expansion	5%

Chemical Composition

Polyethylene wax
Synthetic wax
Others

Specification

Universal type	Green, blue, white, black-grey, beige
Esthetics wax	White, other common colors
Matching processing parameters	Spindle speed:18000r/min Cutter Loading in Rough Machining:0.2min Cutter Loading in Fine Machining:0.05min

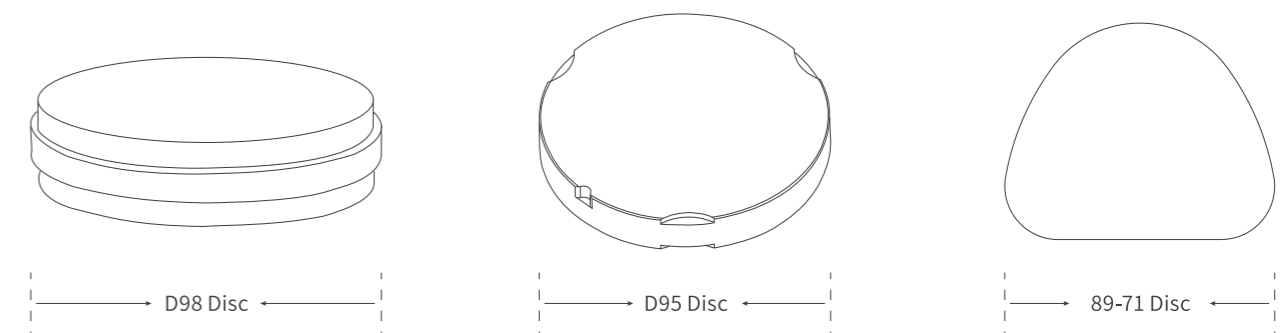





Grinding Tools





01 Diamond Coated Grinder for Zirconia

- High quality emery
- Less generated heat
- Eliminate the hidden cracks

- Fine Grit
- 8000-15000rpm max:25000rpm
- 1pc

					
Item No.	UPTG 01	UPTG 02	UPTG 03	UPTG 06	UPTG 07
Size:φ mm	6.5	5	4.5	16	22
Length:mm	13.0	13.0	13.0	1.5	2.0



- Fine Grit
- 8000-15000rpm max:25000rpm
- 1pc

					
Item No.	UPTG 08	UPTG 09	UPTG 10	UPTG 11	UPTG 12
Size:φ1/10mm	22	15	13	22	15
Length:mm	4.5	3.5	2.0	2.0	2.0

02 Polishing Tools for Aesthetic Restorations

- Applied to glass ceramic, TT, and Explore product lines
- Fast and efficient, eliminate cracks

- Hyper Fine
- 8000-15000rpm max:25000rpm
- 1pc

			
Item No.	UPTF 10	UPTF 02	UPTF 03
Size:φ mm	13	5	4.5
Length:mm	2.0	13.0	13



03 Polishing Tool for Zirconia

- Easy to use
- No polishing paste needed
- Special formula to ensure the durability of product

- Medium
- 7000-15000rpm max:20000rpm
- 1pc

				
Item No.	UPHG 07M	UPHG 06M	UPHG 03M	UPHG 10M
Dimension (mm)	26*2	20*1	4*13	12*2

- Fine
- 7000-15000rpm max:20000rpm
- 1pc

				
Item No.	UPHG 07F	UPHG 06F	UPHG 03F	UPHG 10F
Dimension (mm)	26*2	20*1	4*13	12*2

04 Polishing Tool for Glass Ceramic

- Easy to use
- No polishing paste needed
- Special formula to ensure the durability of product

- Medium
- 7000-15000rpm max:20000rpm
- 1pc

				
Item No.	UPHB 07M	UPHB 06M	UPHB 03M	UPHB 10M
Dimension (mm)	26*2	20*1	4*13	12*2

- Fine
- 7000-15000rpm max:20000rpm
- 1pc

				
Item No.	UPHB 07F	UPHB 06F	UPHB 03F	UPHB 10F
Dimension (mm)	26*2	20*1	4*13	12*2

05 Complete Polishing Kit for Hyramic

- Mainly used for rapid trimming and polishing of hyramic
- More convenient and faster



- 3000-8000 rpm
max:10000 rpm
- 4 pcs/ kit

				
Item No.	RDH086	RDH056	RDH159	RDH157
Dimension (mm)	12X2	5X16	14X2	Customization

Note: The speed should be strictly referred to the recommended one from manufacturer.

06 Basic Polishing Kit for Hyramic

- 3000-8000 rpm
max:10000 rpm
- 3 pcs/ kit

			
Item No.	RDR026	RDR0364	RDR233
Dimension (mm)	5X10	10X1.5	14X2

Note: The speed should be strictly referred to the recommended one from manufacturer.



Corundum Sands

- High purity, excellent self-sharpening, and wearproof
- Low calorific value, high efficiency, acid and alkali resistance
- High temperature resistance and good stability

Specifications	Color	Pure White
	Crystal Form	Three Crystal System
	Hardness (Mohs)	≥9.0
	Melting Point	2250



Sintering Beads

- High strength, high temperature resistance, no adhesion
- Smooth and pearly surface
- Excellent toughness, impact resistance, and grinding resistance

Laboratory Handpiece

Innovative Design for Excellent Experience



Apply to trimming and detachment of dental zirconia, glass ceramic, composites, titanium and mental alloy. Adopting the high quality Taiwanese brushless motor with advanced technology, weaken the vibration and enhance the customer experience.

01

Super torque pedal speed control

02

Active intelligent safety system

03

Optimum for high-end dental lab

03



DIGITAL DENTAL SOLUTIONS

The World's Leading Digital Dental Solutions Provider

DIGITAL DENTAL SOLUTIONS



Lab side

Chair side



GT1
Sintering Furnace



Explore
Multilayer Zirconia



U5
Lab Scanner



5-axis
Dry Milling



Glaze Paste
Realism Glaze & Stains



P2+
Intraoral Scanner



Lithium Disilicate



4-axis
Wet Milling



A7+
Porcelain Furnace



Glaze Paste
Realism Glaze & Stains

P2+

3D Intraoral Scanner

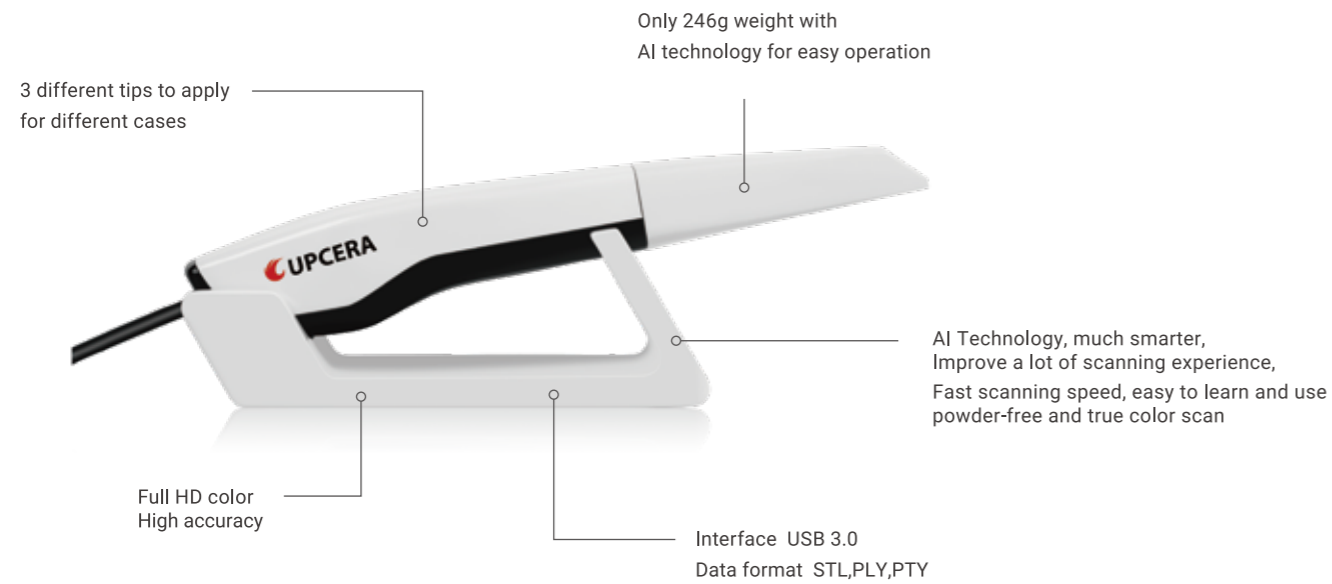

Device Parameter

Scanning Technology	Video Type
Full Jaw Scanning Time	<2 min
Overall Size(L×W×H)	216×40×36 mm
Weight	246 g
Tips	3 Types, Autoclavable
Tip Size(L×W×H)	83x19x14/81x21x17 (D) / 88x21x17 (M) mm
Field of View	18x16 mm
Depth of Field	17 mm
Data Format	STL, PLY, PTY
Inter face	USB 3.0



Specifications

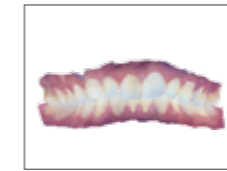

Efficient Treatment Experience

Reproduce the real state of teeth
Accurate anatomical features
3D HD color, visualize communications
Easy and exciting treatment experience

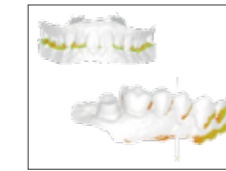

Accurate Shoulder Margin

Clear margin lines, easy to identify
Simplify CAD design
Real-time and accurate display
Improve the success rate of a visit



Convenient Preparation Check

Shade detection, for better preparation
Clear occlusion registration check
Convenient tools for clinics and labs
Adjust and correct production on time



Revolutionary Improvement

Scanning speed improve 50%
Handpiece weight decrease 50%
Data accuracy improve 30%
Height of tips decrease 14%

Applications



Restoration

Accurate and clear shoulder margin brings the efficient design. HD color images help an dentists to distinguish the gingival teeth effectively. One visit, Immediate restoration!



Implant

Fast scan with a wide field of view, easy to capture 3mm data of cuff, accurate scan of metal path pin, no need to do repeat impression and improve patients'treatment experience.

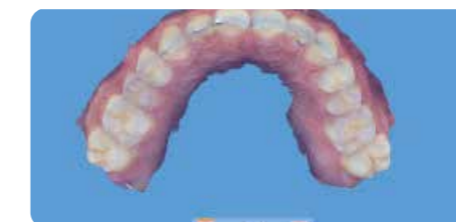

Orthodontics

High accuracy of the full dentition restores the real state of the full arch. Fast get of orthodontic treatment, save time for more patients.

P3

3D Intraoral Scanner

Motion Sensing Function

Not just a gyroscope, but a best human interaction application. Rotate the scanning data with just a wave of the hand. Enjoy the fun of technology.



Start/Stop Button

Not just a button, but a switch to a smarter life. No need to touch the screen/type on the keyboard. Control the scanning process at ease.

Product Feature

- AI Technology, much smarter, improve a lot of scanning experience
- 3 different tips, meet more demands of different applications
- Much smaller, and very easy to operate
- Clear margin line, full HD color, high accuracy
- Fast scanning speed, easy to learn and use
- Powder-free and true color scan

Application Features

Acquisition Technology	Staring Scan
Camera Number	x 3
Scan Field	18x16mm
Scan Depth	20mm
Precision	5µm
Accuracy	10µm
Color	Full HD
Anti Fog System	Intelligent Heating
Full Jaw Scanning Time	1-2 min
True Color	Yes
Handpiece Enclosure	Aviation Aluminum Alloy
Handpiece Dimension	216 x 40 x 36 mm
Handpiece Weight	228g
Tip Types	3types (N/M/D)
Number of Tips included	5
Autoclave Cycle for Tips	30-50 times
Calibrator	Automatic
Scanning Control	Foot Pedal
Image Transfer Interface	USB3.0
Cable Lenght (m)	2m
Cart Touchscreen	Optional
Power Supply Type	AC/DC Medical Power Adapter
Supply Voltage (V)	100-240V/50-60Hz
Supply Current (A)	0.7-1.5A
Storage Temperature (°C)	-10°-55°C



Application Features

- Efficient Treatment Experience**
 Reproduce the real state of teeth
 Accurate anatomical features
 3D high-definition color, visual communication
- Efficient Treatment Experience**
 Clear and easy to identify margin lines
 Compatible with CAD software
 Real-time accurate display
- Revolutionary Improvement**
 Shadow detection for better preparation
 Clear occlusion registration check
 Convenient tools for clinics and laboratories
- Convenient Preparation Check**
 Scanning speed improve 50%
 Data accuracy improve 30%
 Easy and exciting treatment experience

U5

True Color Texture Scanner RPD Design



Scanning large occlusion frame



Auto-alignment



Meet a wide range of restoration cases



Blue light scanning



UPSCAN APP



Marking edge line



Open System



Open System

Scan without blind angle

More comprehensive scanning, more realistic texture

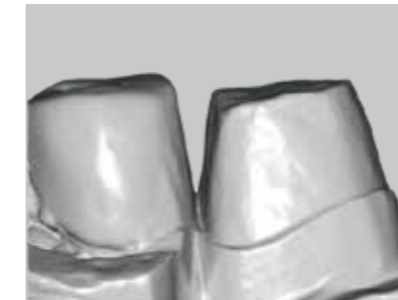

U5 Scanner Structure

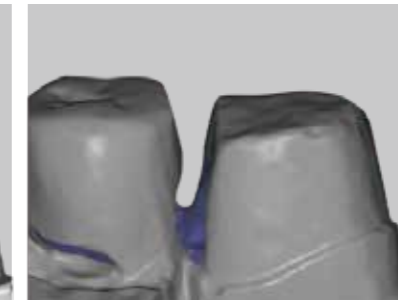

Conventional scanner

Camera principle remains the same, faster, more accurate, more complete scanning. It can scan well with narrow gaps, orthodontic, veneer, and undivided models.

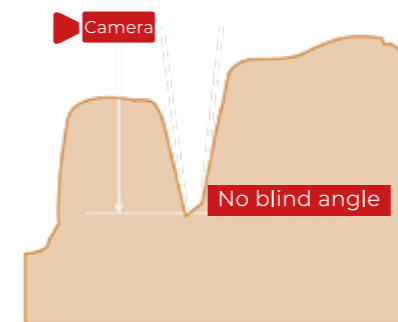

U5 Scanner Structure

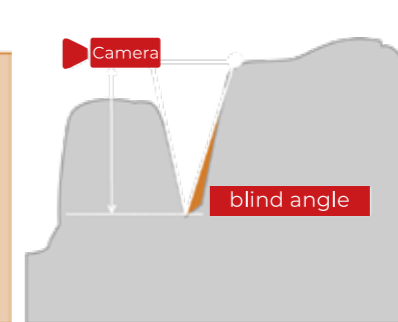

Conventional scanner

One-time scanning full arch implant

No need to unscrew the abutment, significantly improving the scanning efficiency of implant restorations

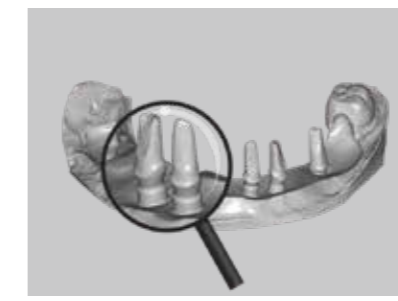

U5 Scanner Structure

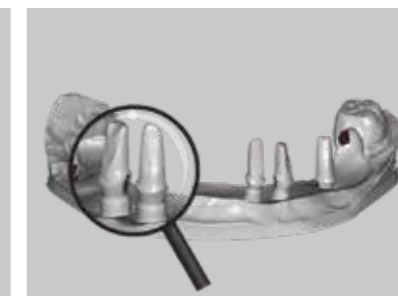

Conventional scanner

A41

4-Axis Dry Milling Machine



- Simple & friendly UI
- High-quality outcomes at favorable cost



Touch screen operation



Tremendous stability and high accuracy



24/7 non-stop machining



Low pressure protection



Top class mechanical & electrical parts



High performance casting steel

Device Parameters

Specification	Parameters
Dimensions	54*49*53cm
Weight	85kg
Voltage	220V 50Hz ; 110V 60Hz
Power	<1KW
Compatible Compressed Air	0.5-0.8Mpa
Spindle Speed	60,000 rpm
Precision	< 0.01mm
Number of Bur	4
Cooling Type	Air cooling
Materials	Zirconia, PMMA, Wax, PEEK
Application	Coping, full contour, bridges, inlay, veneer, post-core crown, onlay, PEEK framework
Processing Speed	Zirconia, PMMA(10 mins/unit, Wax(3 mins/unit)

A51

5-Axis Dry Milling Machine



- High stability and accuracy
- Top class mechanical & electric parts
- Automatic tool changer
- 24/7 non-stop machining
- Power-off and low air-pressure protection
- High-performance casting steel and aviation aluminum alloy structures

Materials



ZIRCONIA

PMMA

WAX

PEEK

Indications



Pre-milled Abutment

Implant Bridge

Post-core Crown

Veneer

Surgical Guide

Device Parameters

Specification	Parameters
Dimensions	53*47*56cm
Weight	110kg
Voltage	200V 50HZ ; 110V 60Hz
Power	< 1.0KW
Compatible Compressed Air	0.5-0.8Mpa
Precision	< 0.01MM
Number of Bur	6
Cooling Type	Air cooling
Application	Coping, full contour crown, bridge, inlay, onlay, veneer, post-core crown, telescopic crown, customized abutment crown, overstructure, PEEK framework
Processing Speed	Zirconia, PMMA (10 mins/unit), Wax(3 mins/unit)

A52

The 5-Axis Dry Milling Powerhouse

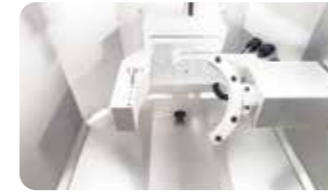

Spindle Speed: **80,000 rpm**



Precision: **<0.01mm**



90° Vertical Milling

- 5-axis simultaneous milling
- Integrated fully enclosed milling chamber for outstanding sealing and dustproof
- Built-in PC with a 12-inch touchscreen
- Equipped with servo motor and ball screw with less than 0.01mm precision
- High-performance aircraft-grade aluminum alloy housing
- Up to 90° large angle for buccal side cutting
- Automatic tool changer and tool setter detection

Device Parameters

Specification	Parameters
Dimensions	55*49*74cm
Weight	110kg
Voltage	220V 50Hz ; 110V 60Hz
Power	<1.0kw
Compatible Compressed Air	0.5-0.8Mpa
Spindle Speed	80,000rpm
Tilt Angle	A axis: ±360°, B axis: +35°/-125°
Precision	<1.0mm
Number of Bur	6
Cooling Type	Air cooling
Materials	Zirconia, PMMA, PEEK, Wax, Wood(D98.5, Max height 30mm)
Processing Speed	Zirconia, PMMA, PEEK (10 mins/unit), Wax(3 mins/unit)
Application	Coping, full contour crown, bridge, inlay, onlay, veneer, post-core crown, telescopic crown, customized abutment crown, overstructure, peek framework

A52W

The 5-Axis Wet Milling Powerhouse



- Build-in solid water tank
- Reliable capacitive touch screen, user-friendly UI
- Applicable with 3 units of Pre-mill or 4 units of Glass ceramic block
- Stable and powerful spindle ensures high precision results
- Protection module against power failure and low air pressure
- 24 Hours non-stop machining

Materials



Device Parameters

Specification	Parameters
Dimensions	55*49*74cm
Weight	110kg
Voltage	220V 50Hz ; 110V60Hz (optional)
Power	1.0kw
Compatible Compressed Air	0.5-0.8Mpa
Spindle Speed	80,000rpm
Tilt Angle	A axis: ±360°, B axis: +35°
Precision	<0.01mm
Number of Bur	12
Cooling Type	Water cooling (Built-in water tank)
Materials	Galss-ceramic, premill, PEEK, PMMA Wax (Φ98.5mm, thickness of 10mm-30mm)
Processing Speed	Pre-milled abutment (40 mins/unit), glass-ceramic (10-30 mins/unit) PEEK, PMMA (10 mins/unit), Wax (3 mins/unit) framework (Wax / PEEK, 45/ 150 mins/unit)
Application	Crown, inlay, onlay, bridge, splints, BPS, framework pre-milled abutment, abutment on Ti base one-piece abutment

A53

5-Axis Disc Changer Milling Machine



- Internet of Things(IoT) technology
- 12-inch touch screen
- Outstanding stability and high accuracy
- Premium spindle with automatic tool changer
- Real time monitoring
- High performance castings, aerospace aluminum alloys
- Low air pressure protection
- 24/7 non-stop machining

Materials



ZIRCONIA

PMMA

WAX

PEEK

Device Parameters

Specification	Parameters
Dimensions	100*70*85cm
Weight	220kg
Voltage	220v 50Hz
Power	1.5kw
Compatible Compressed Air	0.55-0.8Mpa
Spindle Speed	80,000rpm
Tilt Angle	A-axis +33°/-95°, B-axis ±360°
Precision	<0.01mm
Number of Bur	12
Blank Tank	24
Cooling Type	Air Cooling
Materials	Zirconia, Resin, Wax, PEEK
Processing Speed	Zirconia, Resin (10mins/unit), Wax(3mins/unit)
Application	Coping, full crown, bridge, inlay, onlay, veneer, post-core crown, telescopes, personalized abutment, hybrid implant bridge, denture



B42

Pre-milled Abutment Milling Machine

- 12-inch touch screen
- Top stability and high accuracy
- Outstanding performance spindle
- 24/7 non-stop machining
- Simple to use
- Top class components
- One-cast steel structure
- Low air pressure protection

Device Parameters

Specification	Parameters	Specification	Parameters
Dimensions	65*65*175cm	Number of Bur	15
Weight	380kg	Cooling Type	Water cooling
Voltage	220V 50Hz 110V 60Hz (Optional)	Materials	Titanium block, Glass ceramic PMMA, PEEK(optional)
Power	4.0KW	Application	Pre-milled abutment, full contour crown inlay, onlay, veneer, framework(optional)
Compatible Compressed Air	0.5-0.8Mpa	Processing Speed	Pre-milled abutment(15 mins/unit) Glass ceramic(10-30 mins/unit) Mental crown(25 mins/unit) Framework(120 mins/unit)
Spindle Speed	60,000rpm		
Precision	< 0.01mm		



B52

Screw-retained Bridge & Bar Milling Machine

- 12-inch touch screen, easy-to-use UI
- High Stability, high precision
- Easy to use, 24 hours continuously run
- One-cast steel structure delivers the highest stability ensure more stable operation
- High performance spindle with automatic tool changer
- Top class mechanical & electrical parts, protection module power against failure and low air pressure

Device Parameters

Specification	Parameters	Specification	Parameters
Dimensions	65*65*175cm	Number of Bur	16
Weight	400kg	Cooling Type	Water cooling
Voltage	220V 50Hz 110V 60Hz (Optional)	Materials	Titanium disc, PMMA, Pre-milled, Wax Co-cr disk / Glass ceramic (optional)
Power	4.5KW	Application	Customized abutment, implant bridge bar clip, pre-milled abutment inner coping,full crown bridge / inlay, veneer (optional)
Compatible Compressed Air	0.55-0.8Mpa	Processing Speed	Customized butment(40 mins/unit) Pre-milled butment(15 mins/unit) Glass ceramic(10-30 mins/unit) PMMA(10 mins/pcs), Wax(3 mins/unit) Titanium framework (180 mins/unit)
Spindle Speed	60,000rpm		
Processing accuracy	< 0.01mm		
Rotation Angle	A axis is ±30°, B axis is ±360°		



C41 4-Axis Wet milling Machine

- Compact and ergonomic design
- Built-in automatic circulating water system
- Rapid and accurate production with added efficiency
- Versatile indications up to 40 mm block
- Ideal for lab and clinic for same day restorations

Device Parameters

Specification	Parameters
Dimensions	45*35*42cm
Weight	45kg
Voltage	220V 50Hz
Power	<0.1KW
Compatible Compressed Air	0.4-0.6Mpa
Spindle Speed	80,000rpm
Precision	< 0.01mm
Number of Bur	5
Cooling Type	Water cooling
Materials	Composite Resin Block, Glass ceramic, Titanium Block PMMA, Hyramic
Application	Veneer, full contour crown, inlay, onlay, pre-milled abutment
Processing Speed	Resin(12 mins/unit), Glass ceramic(10-30 mins/unit), Pre-milled abutment(40 mins/unit)



D41 Titanium Denture Framework Milling Machine

- 15-inch touch screen
- Automatic tool changer
- Accurate 4-axis machining
- Special-designed milling bur for undercut
- One-cast stell structure delivers the highest stability
- Top class mechanical & electrical parts
- Low air pressure protection



Device Parameters

Specification	Parameters
Dimensions	120*100*180cm
Weight	1500kg
Voltage	220V 50Hz ; 380V 50Hz (Optional)
Power	5.5KW
Spindle Speed	40,000rpm
Precision	< 0.01mm
Number of Bur	7
Cooling Type	Water cooling
Materials	Titanium disc or block, Co-cr, Composite Resin, Titanium block(optional)
Application	Denture framework, mental crown, pre-milled abutment(optional)
Processing Speed	Denture framework (150 mins/unit), Pre-milled abutment(15 mins/unit) Resin(10 mins/unit), Mental crown(25 mins/unit)



GT1

Zirconia Sintering Furnace

- GT1 is a new type of fast sintering furnace with silicon-carbide(SiC) as the heating element, which features minor contamination to zirconia.
- LCD display realizes real-time monitoring of furnace voltage, current, and temperature with better efficiency and stability.
- Firing temperatures up to 1550°C. 18 built-in sintering programs are equipped with 5 stages for each program that enables meeting various zirconia sintering needs from different curves.

Device Parameters

Specification	Parameters
Dimensions	42*46.5*80cm
Net Weight	26.5kg
Input Voltage	200-240V
Max Power	2.5KW
Max Working Temperature	1550°C
Protection Level	IP21
Fast Fuse	-500V/32A
Fuse	①:2-380V/16A ②: -250V/0.5A ③: -250V/1A



C1

Speed Sintering Furnace

- **Two Modes**
Normal Sintering & Fast sintering
- **High Efficiency**
- **Excellent Result after 45mins Sintering**

Device Parameters

Specification	Parameters
Rated Voltage	220±10%
Rated Frequency	50Hz
Rated Power	1500W
Protection Level	IP21
Dimensions	325*585*745mm

Specification	Parameters
Protective Tube1	2x ~380V 16A
Protective Tube2	~250V 0.5A
Protective Tube3	~250V 1A
Speed Protective Tube	~500V 32A
Net Weight	69KG



A7+
Porcelain Furnace

- Double-layer metal protection to the chamber
- Integrated vacuum technology
- Automatic platform lift mode
- Built-in error warning
- 2-Stage program to meet special sintering demands
- Temperature compensation
- Vacuum testing, cleaning, drying, and other maintenance procedures
- Unique, homogenous heat distribution

Device Parameters

Specification	Parameters
Dimensions	33*42*56cm
Weight	26.5kg
Voltage	220V 50Hz ± 10%
Heating Rate	10-100°C
Maximum Input Voltage	1200w+350w
Maximum Working Temperature	1150°C
Ultimate Vacuum Degree	<30mmhg
Constant Temperature Time	00:30-30:00min
Chamber Available Sizes	φ 85x55(mm)
Waterproof Level	IPX1
Fuse	Fuse 1: 3.0A Fuse 2: 8.0A

Reliable
Materials
Expert

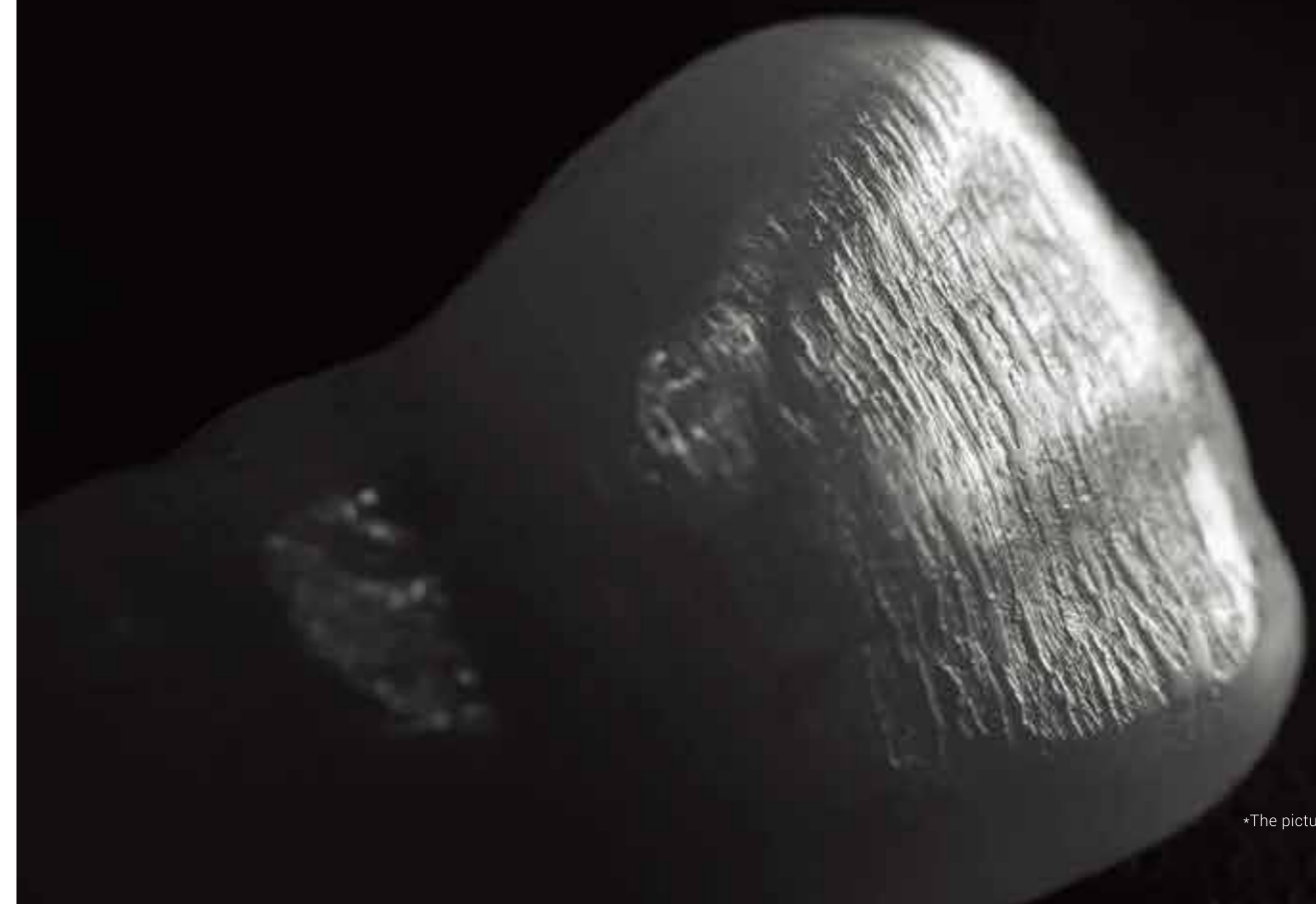



Jiang Shan

Famous Dental Aesthetic Restoration Expert in China

